

H₂O_G

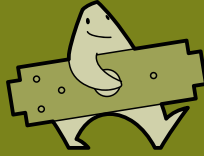

rainwater H₂O_G storage solution
INSTALLATION GUIDE

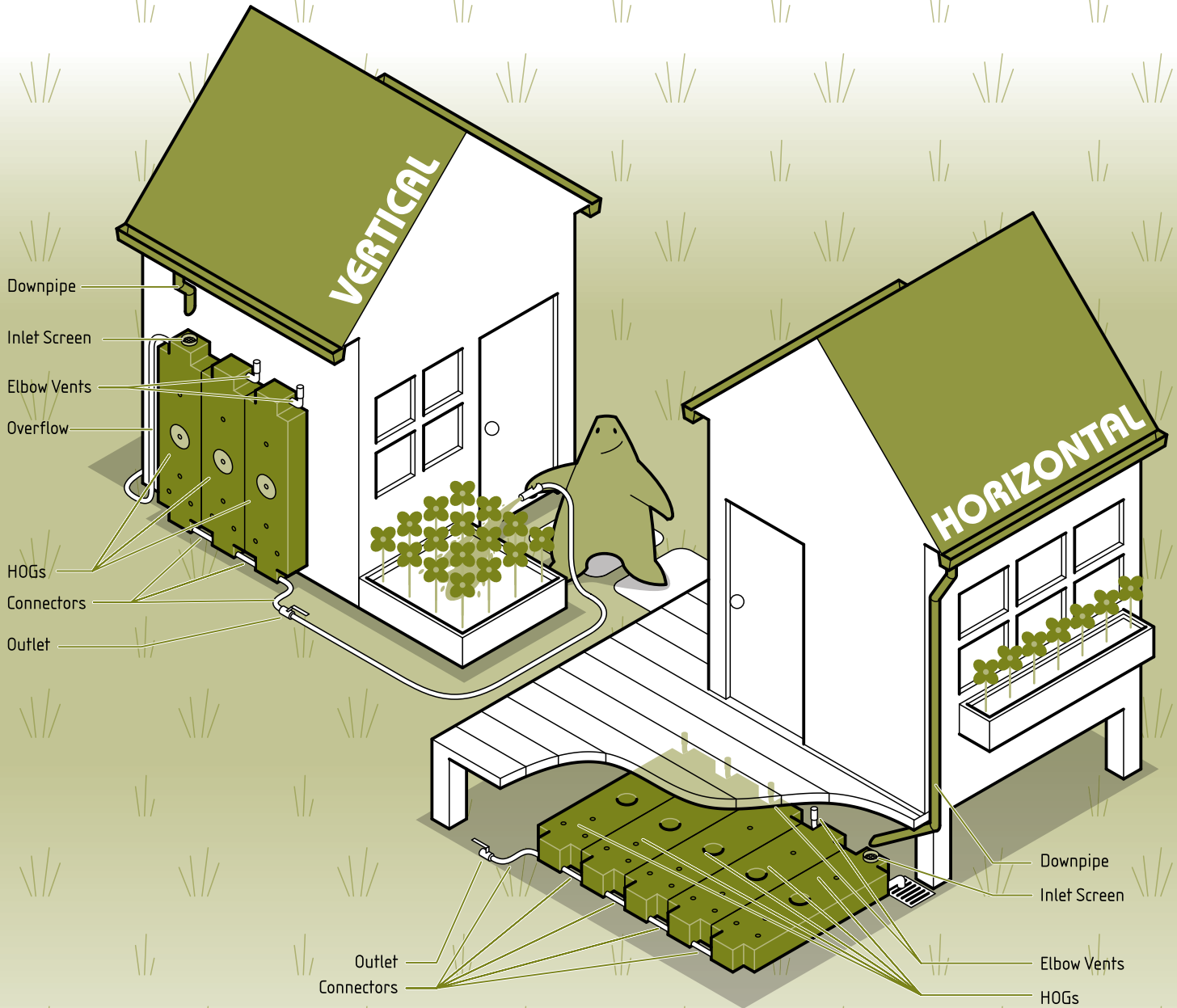

YOU WILL NEED:

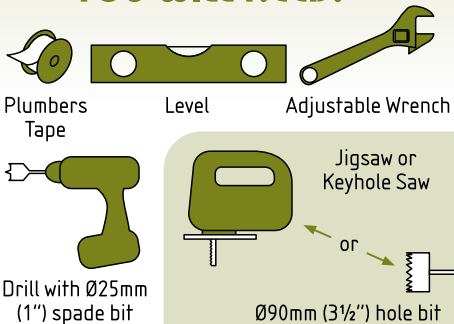

HOGs are designed to connect together using the supplied parts. Threaded Brass inserts at the top and bottom of each HOG allow secure attachment of Connectors, Vents and Outlets. Use a Ø25mm (1") spade bit to drill out the holes, taking care not to damage the threads. Screw in the Connectors, Elbow Vents and Outlet. Seal the threads with plumbers tape to prevent leaks.

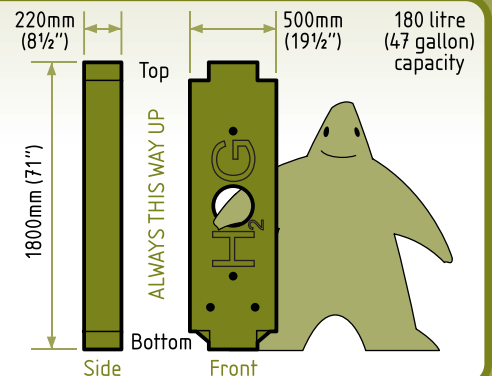

INSTALLATION

HORIZONTAL (ON GROUND / UNDER DECKS)

1. Arrange HOGs on a slope of 1 in 100 (1°) with the inlet (top) end higher than the outlet (bottom) end. You may need to provide a thin layer of sand to ensure an even bearing surface and to create the required fall.
2. Ensure HOGs don't slip or move when full. Use stakes, blocks or bedded sand if necessary.
3. Cut Ø90mm (3½") hole in the first HOG.
4. Attach elbow vents to the top holes, and Connectors and Outlet to bottom holes.
5. Attach and direct overflow hose (see 'Plumbing').
6. Place Inlet Screen into inlet hole under downpipe (see 'Plumbing').

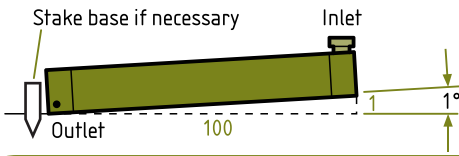
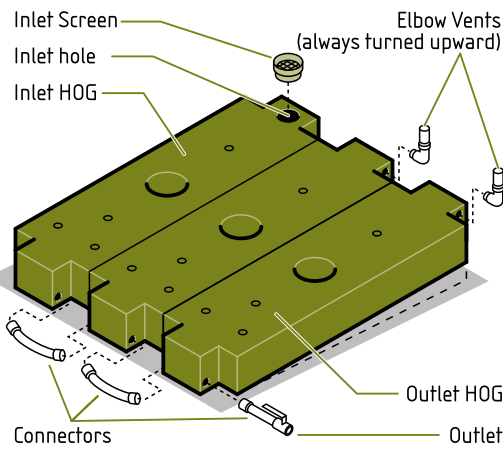

WARNING

- Each HOG weighs 200kg (440lb) when full.
- HOGs must always be installed so that the weight is supported on a firm surface.
- Always ensure that the HOG is secure.
- The Wall Kit stabilises the HOG laterally and is NOT intended to carry any weight. Wall mounted HOGs must be installed bearing on the ground or another stable structure.

VERTICAL (ON WALL)

1. Place Wall Channels horizontally at center height of 900mm (35½") from base level and fix to wall using appropriate fixings (not supplied). Ensure the HOGs are sitting on a firm, stable and level surface. Ensure the HOGs are the right way up (the "G" should be at the top).
2. Position Spring Nuts 500mm (19½") apart between HOGs and 250mm (9¾") from edge.
3. Cut Ø90mm (3½") hole in the indicated face of the inlet HOG for the Inlet Screen.
4. Attach Elbow Vents to the top holes and attach Connectors and Outlet to bottom holes.
5. Attach and direct overflow hose (see 'Plumbing').
6. Place Inlet Screen into inlet hole under downpipe (see 'Plumbing').
7. Stand HOG in position and bolt the Plate through the HOG into the Spring Nut.

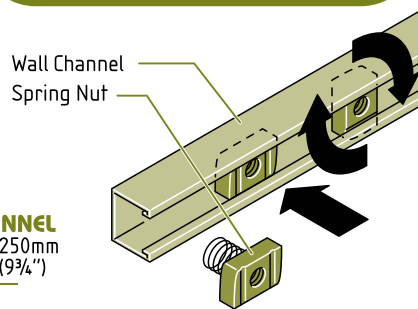
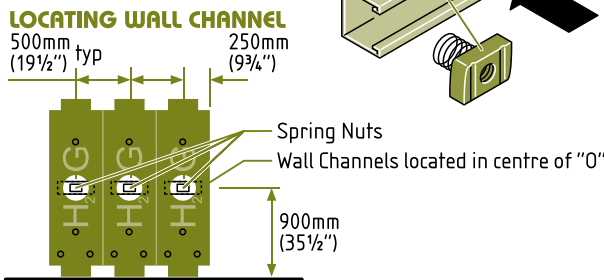

WALL KIT

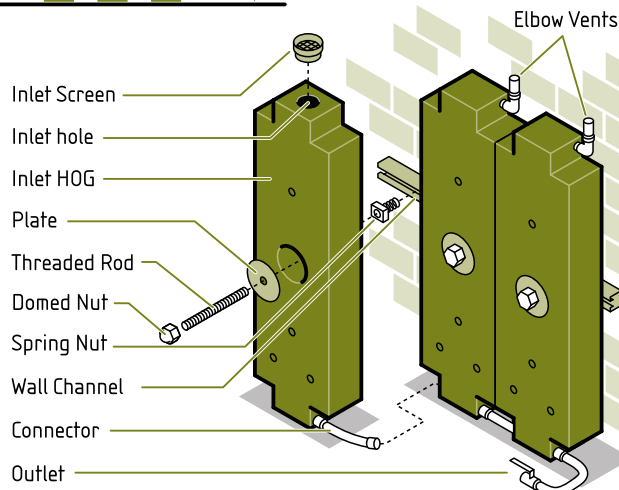
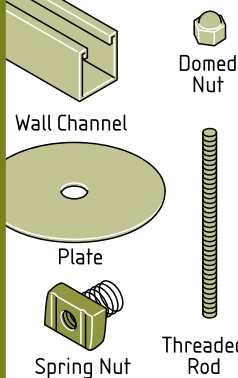

PLUMBING

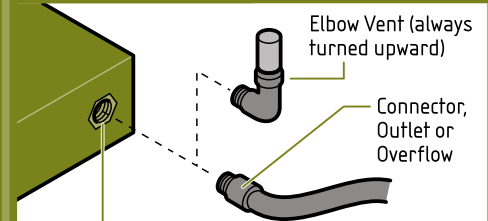

Threaded Brass Insert
Use a Ø25mm (1") spade bit to drill out the hole, taking care not to damage the threads.

VENTING

Install Elbow Vents at the highest point on all HOGs to allow air to escape. The Inlet HOG is automatically vented by the Inlet Screen.

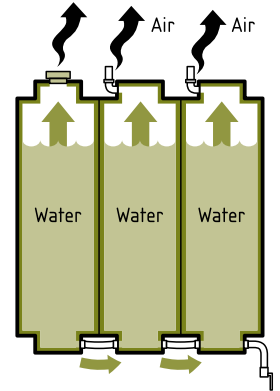

INLET

Cut a Ø90mm (3½") inlet hole using a drill or jigsaw. The inlet hole must be on a horizontal face of the inlet HOG at the highest point and underneath the downpipe. Place Inlet Screen into the hole.

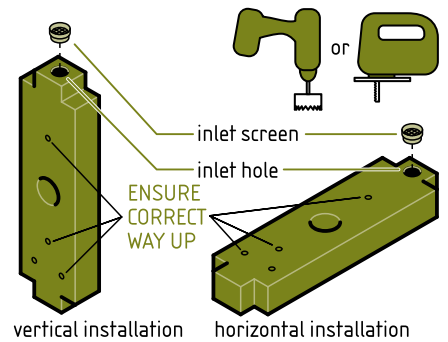

DOWNPIPE

Cut the downpipe on a 45° angle, with the lowest point 80mm (3") above the screen to allow leaves to disperse. Clean screen out periodically.

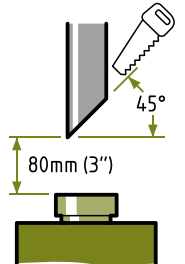

OVERFLOW

Attach an extra hose (not supplied) for any overflow water by screwing the hose fitting into the top threaded connector point in any of the HOGs. Direct the overflow as desired using the hose.

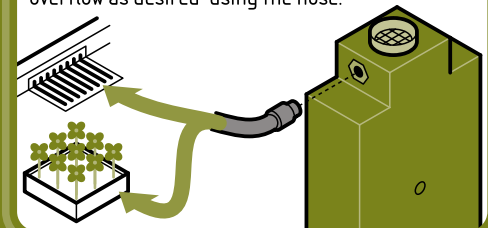

H₂O_G

Bluewater Tanks • Phone 1300 668 570 • Fax 1300 786 570
sales@bluewatertanks.com.au • www.bluewatertanks.com.au

